

Slijtdelen voor grondverzetmateriaal

Tanden en slijtdelen MTG :

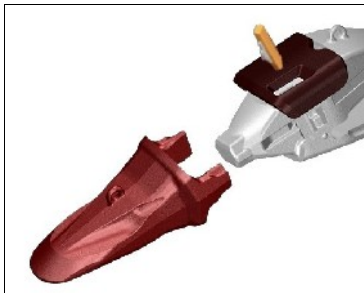

POBENCO utilise les dents MTG en première monte !!!



Kingmet



Fixmet

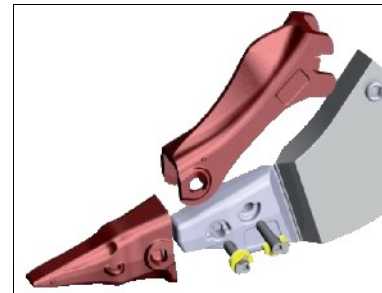

Ripmet

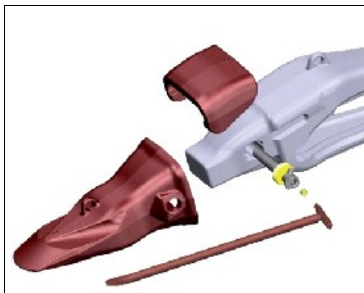

Starmet

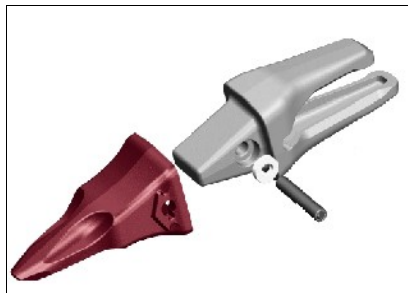

Compatible Caterpillar



Promet

Andere tanden :

Volvo, Esco, Bofors, Combi, Uni-Z, Liebherr, AE, Case, Feurst, Caterpillar, Komatsu,, opschroeftanden, ...

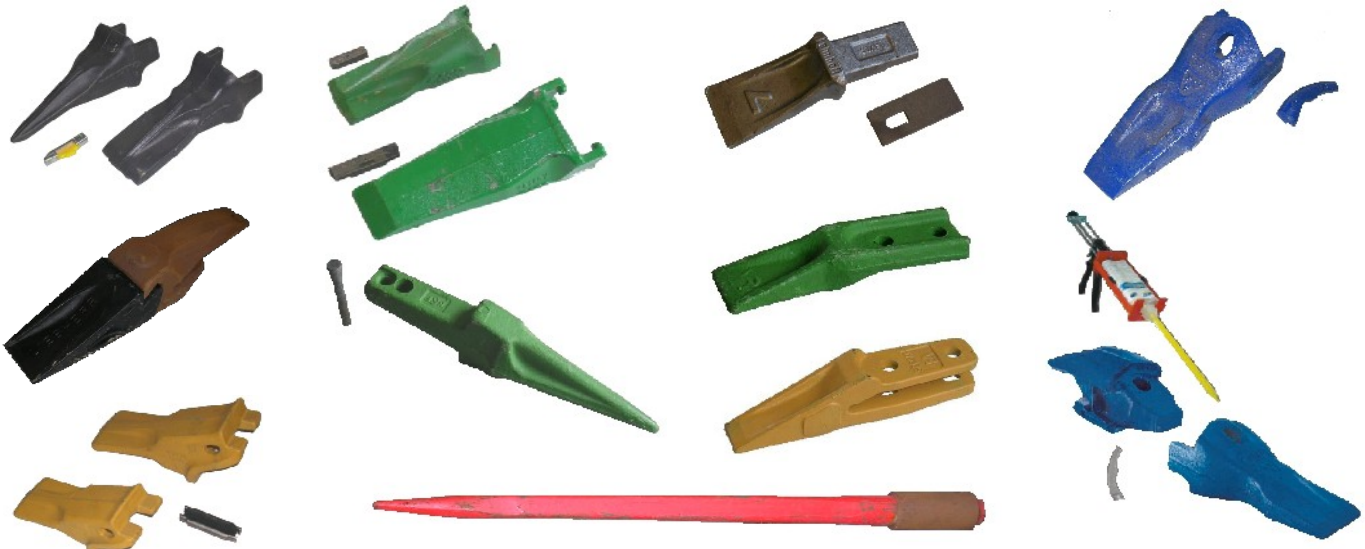

Messen, onderschroefmessen, segmenten en schroefwerk

Messenstaal enkele afschiuning :

Leverbaar uit slijtvast staal 400Hb of 500Hb.
Afmetingen : van 100x12mm tot 600x80mm.

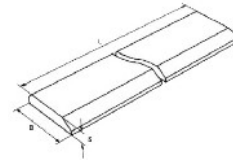

'Delta' messen :

Voor 'Rots' dieplepel of laadbak.
Op maat gemaakt.



Omkeerbaar onderschroefmes :

Leverbaar uit slijtvast staal 500Hb.
Op maat gemaakt..

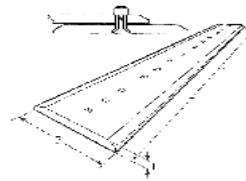

Segmenten, Slijtplaten, Bulldozer hoekmessen :

Leverbaar uit slijtvast staal 500Hb.
Op maat gemaakt.

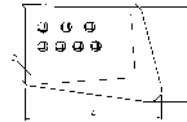

Schroefwerk voor onderschroefmessen, segmenten,... :

Kwaliteit 10.9
Diverse modellen leverbaar.



Pijlmessen (P Profiel) :

Bescherm het moedermes van de bak.
Uit slijtvast staal 450Hb/500Hb.

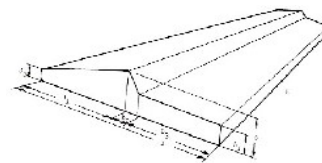

Profiel slijstaven (BOF Profiel) :

Voor het vervangen van ketting-strips.
Uit slijtvast staal 450Hb/500Hb.

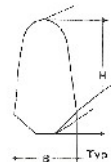

Andere slijtdelen

Lasthaken :

Hefvermogen : 1T - 2,5T - 5T - 10T of 18 Ton.
Klepstejes ook leverbaar.



Slijtdelen met chroomstaal :

Chroomstaal op een plaat lasbaar staal.
Leverbaar in platen, noppen, tabletten,...



CW haken uit Hardox-400 :

Modellen : 'bak', 'hamer' & 'twin' (omkeerbaar).
Gegoten versterkingskap voor CW haken.



Onderdelen voor CW snelkoppeling :

Cylinder, veren, stangen, spie,...

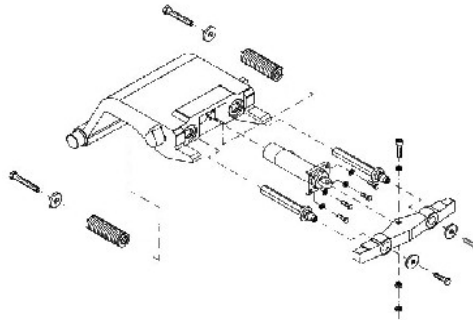

Onderdelen voor RETROMATIC snelkoppeling :

Veren, as, sleutels,...

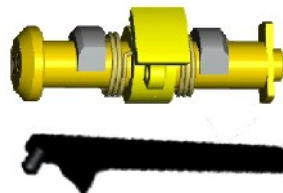

Ombouwplaten voor bakken :

Retromatic,
Lehnhoff,
Klac,
Atlas,...



Rubbere rupsen voor mini-gravers :



Beitels voor hydraulische sloophamers :

